

## 1 Channel Ultra-low Capacitance ESD Protection

### 1. Features

- Ultra-Low capacitance:0.05pF(typ.)
- Low leakage current(<10nA)
- Fast response time(<1ns)
- Bi-directional,single line protection
- IEC 61000-4-2 (ESD Air): 15kV  
IEC 61000-4-2 (ESD Contact): 8kV

### 2. Pin Description

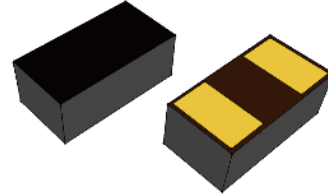

### 3. Applications

- USB 3.0/3.1
- HDMI 1.3/1.4/2.0
- RF Antenna
- SATA and eSATA Interface

### 4. Schematic Diagram

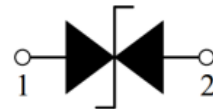

### 5. Order Information

Type	Package	Size (mm)	Delivery Form	Delivery Quantity
SLPED0201M05	0201	1.00x0.52x0.38	7" T&R	15,000

### 6. Limiting Values( $T_A = 25\text{ }^\circ\text{C}$ , unless otherwise specified)

Symbol	Parameter	Conditions	Min	Max	Unit
$V_{ESD}$	Electrostatic Discharge Voltage	IEC 61000-4-2; Contact Discharge	-	8	kV
		IEC 61000-4-2; Air Discharge	-	15	kV
$T_A$	Operating Temperature Range	-	-55	125	$^\circ\text{C}$
$T_{stg}$	Storage Temperature Range	-	-40	85	$^\circ\text{C}$

### 7. Electrical Characteristics( $T_A = 25\text{ }^\circ\text{C}$ unless otherwise specified)

Symbol	Parameter	Conditions	Min	Typ.	Max	Unit
$V_{DC}$	Continuous Operating Voltage	-	-	-	5.0	V
$V_T$	Trigger Voltage	IEC61000-4-2 8kV contact discharge	-	450	-	V
$V_C$	Clamping Voltage	IEC61000-4-2 8kV contact discharge	-	40	-	V
$I_L$	Leakage Current	DC 5V shall be applied on component	-	-	10	nA
$C_J$	Capacitance	Measured at 10MHz	-	0.05	-	pF

**8. Typical Characteristics**

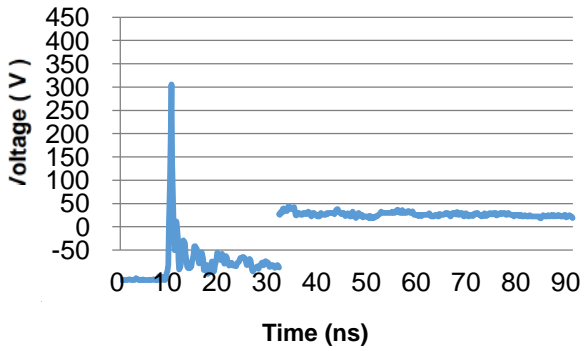

Fig.1 Typical ESD Response  
(IEC 61000-4-2, 8kV contact discharge)

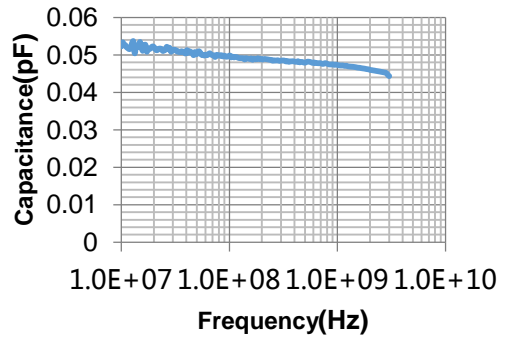

Fig.2 Typical Device Capacitance VS. Frequency

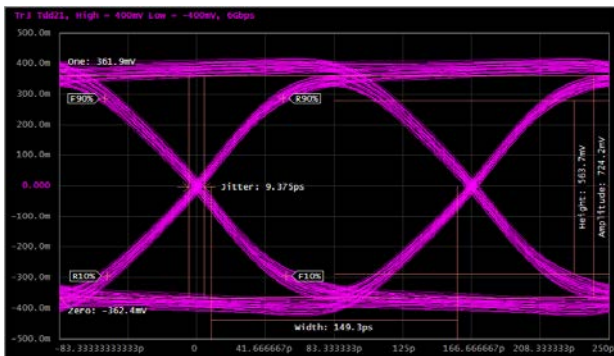
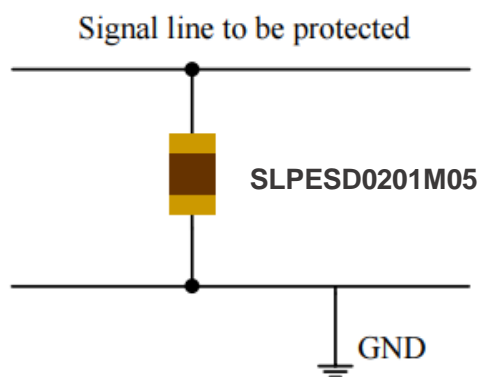
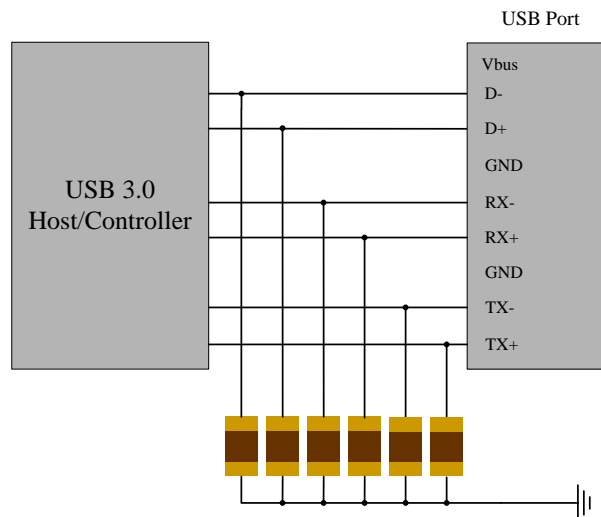

Fig.3 HDMI 2.0 Mask at 6.0 Gbps

## 9. ESD Protection for Signal Line

The SLPESD is designed for the protection of one bidirectional data line from ESD damage.

- Place the SLPESD as close to the input terminal or connector as possible.
- Minimize the path length between the SLPESD and the protected signal line.
- Use ground planes whenever possible.



**10. Package Dimension**

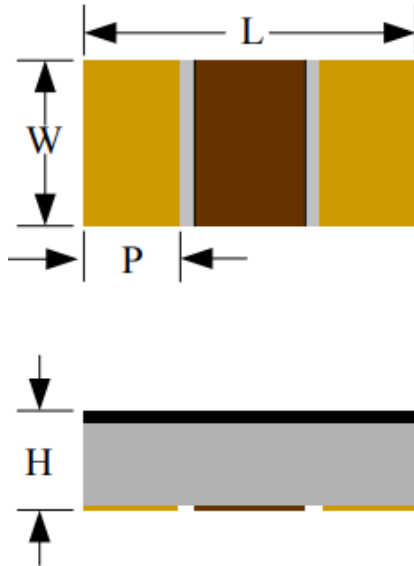

**Recommended Solder Pad Footprint**

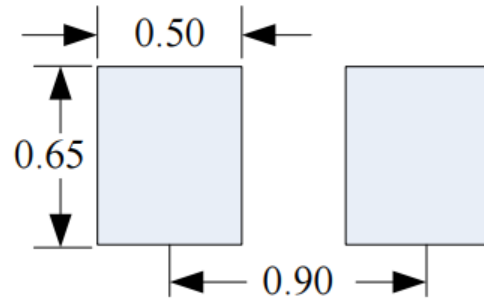

**\*Sizes in mm**

Notes:

This solder pad layout is for reference purposes only.

Dimension	Unit: Millimeters	
	Min.	Max.
L	0.90	1.10
W	0.42	0.62
p	0.15	0.35
H	0.25	0.45

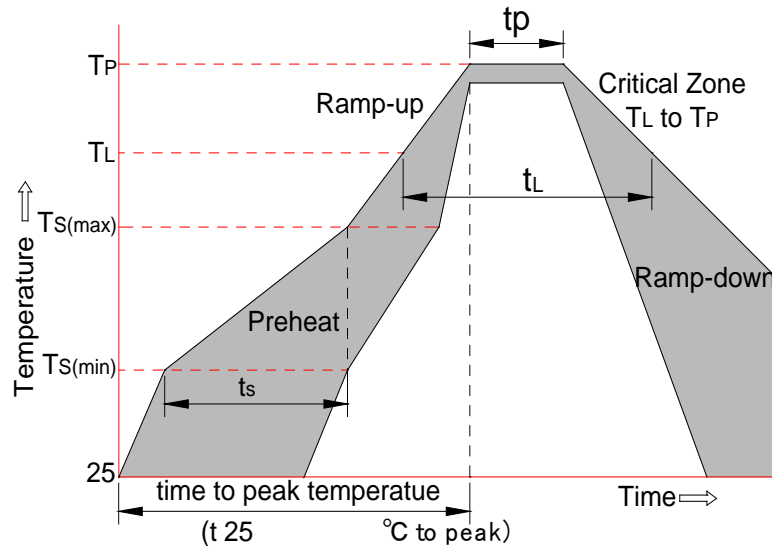
**11. Soldering Parameters**

Reflow Condition		Pb-Free Assembly
Pre-heat	-Temperature Min ( $T_{s(min)}$ )	+150°C
	-Temperature Max( $T_{s(max)}$ )	+200°C
	-Time (Min to Max) ( $t_s$ )	60-180 secs.
Average ramp up rate (Liquid us Temp ( $T_L$ ) to peak)		3°C/sec. Max
$T_{s(max)}$ to $T_L$ - Ramp-up Rate		3°C/sec. Max
Reflow	-Temperature( $T_L$ )(Liquid us)	+217°C
	-Temperature( $t_L$ )	60-150 secs.
Peak Temp ( $T_p$ )		+260(+0/-5)°C
Time within 5°C of actual Peak Temp ( $t_p$ )		30 secs. Max
Ramp-down Rate		6°C/sec. Max
xTime 25°C to Peak Temp ( $T_p$ )		8 min. Max
Do not exceed		+260°C