

200V N-Channel Enhancement Mode MOSFET

Description

The SL18N20 is silicon N-channel Enhanced VDMOSFETs, is obtained by the self-aligned planar Technology which reduce the conduction loss, improve switching performance and enhance the avalanche energy. The transistor can be used in various power switching circuit for system miniaturization and higher efficiency.

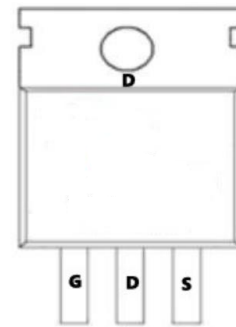
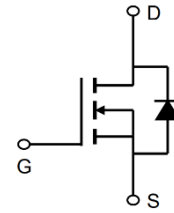

General Features

$V_{DS} = 200V$ $I_D = 18A$

$R_{DS(ON)} < 150m\Omega$ @ $V_{GS}=10V$ (Type: 120m Ω)

Application

Uninterruptible Power Supply(UPS)

Power Factor Correction (PFC)

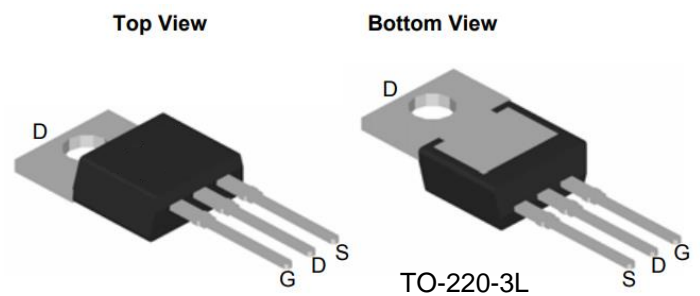

Absolute Maximum Ratings ($T_C=25^\circ C$ unless otherwise noted)

Symbol	Parameter	Value	Unit
		TO-220-3L	
VDSS	Drain-Source Voltage ($V_{GS} = 0V$)	200	V
ID	Continuous Drain Current	18	A
IDM	Pulsed Drain Current (note1)	72	A
VGS	Gate-Source Voltage	± 20	V
EAS	Single Pulse Avalanche Energy (note2)	340	mJ
IAR	Avalanche Current (note1)	15	A
EAR	Repetitive Avalanche Energy (note1)	8.3	mJ
PD	Power Dissipation ($T_C = 25^\circ C$)	104	W
TJ, Tstg	Operating Junction and Storage Temperature Range	-55~+150	$^\circ C$
RthJC	Thermal Resistance, Junction-to-Case	1.2	$^\circ C/W$
RthJA	Thermal Resistance, Junction-to-Ambient	62.5	$^\circ C/W$

Electrical Characteristics (T_J=25°C, unless otherwise noted)

Symbol	Parameter	Test Conditions	Min.	Typ.	Max.	Unit
V(BR)DSS	Drain-Source Breakdown Voltage	V _{GS} = 0V, I _D = 250μA	200	220	--	V
IDSS	Zero Gate Voltage Drain Current	V _{DS} = 200V, V _{GS} = 0V, T _J = 25°C	--	--	5	μA
		V _{DS} = 160V, V _{GS} = 0V, T _J = 125°C	--	--	100	
IGSS	Gate-Source Leakage	V _{GS} = ±20V	--	--	±100	nA
VGS(th)	Gate-Source Threshold Voltage	V _{DS} = V _{GS} , I _D = 250μA	2.0	3.0	4.0	V
RDS(on)	Drain-Source On-Resistance (Note3)	V _{GS} = 10V, I _D = 9A	--	120	150	mΩ
C _{iss}	Input Capacitance	V _{GS} = 0V, V _{DS} = 25V, f = 1.0MHz	--	1318	--	pF
C _{oss}	Output Capacitance		--	180	--	
C _{rss}	Reverse Transfer Capacitance		--	75	--	
Q _g	Total Gate Charge	V _{DD} = 160V, I _D = 18A, V _{GS} = 10V	--	41	--	nC
Q _{gs}	Gate-Source Charge		--	5.5	--	
Q _{gd}	Gate-Drain Charge		--	19.5	--	
td(on)	Turn-on Delay Time	V _{DD} = 100V, I _D = 18A, R _G = 25 Ω	--	24	--	ns
t _r	Turn-on Rise Time		--	45	--	
td(off)	Turn-off Delay Time		--	101	--	
t _f	Turn-off Fall Time		--	95	--	
I _s	Continuous Body Diode Current	T _C = 25 °C	--	--	18	A
ISM	Pulsed Diode Forward Current		--	--	72	
V _{SD}	Body Diode Voltage	T _J = 25°C, I _{SD} = 18A, V _{GS} = 0V	--	--	1.4	V
t _{rr}	Reverse Recovery Time	V _{GS} = 0V, I _s = 18A, di _F /dt = 100A /μs	--	230	--	ns
Q _{rr}	Reverse Recovery Charge		--	1.8	--	μC

Note :

- 1、 The data tested by surface mounted on a 1 inch² FR-4 board with 2OZ copper.
- 2、 The EAS data shows Max. rating . I_{AS} = 15A, V_{DD} = 50V, R_G = 25 Ω, Starting T_J = 25 °C
- 3、 The test condition is Pulse Test: Pulse width ≤ 300μs, Duty Cycle ≤ 1%
- 4、 The power dissipation is limited by 150°C junction temperature
- 5、 The data is theoretically the same as ID and IDM , in real applications , should be limited by total power dissipation.

Typical Characteristics

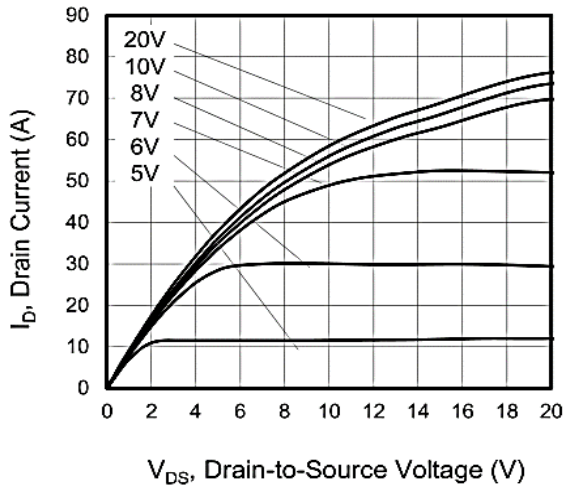

Figure 1. Output Characteristics ($T_J = 25^\circ\text{C}$)

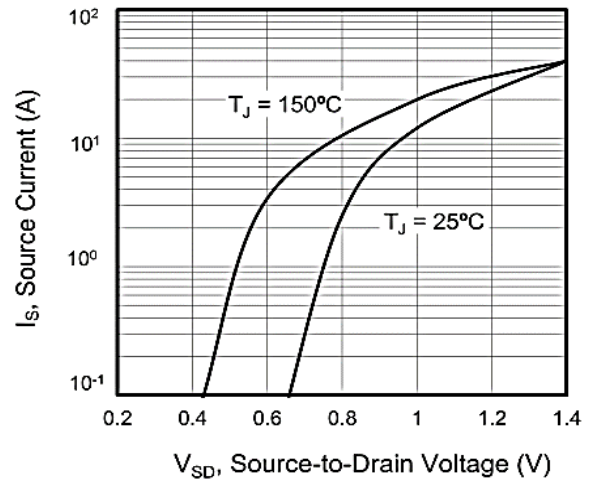

Figure 2. Body Diode Forward Voltage

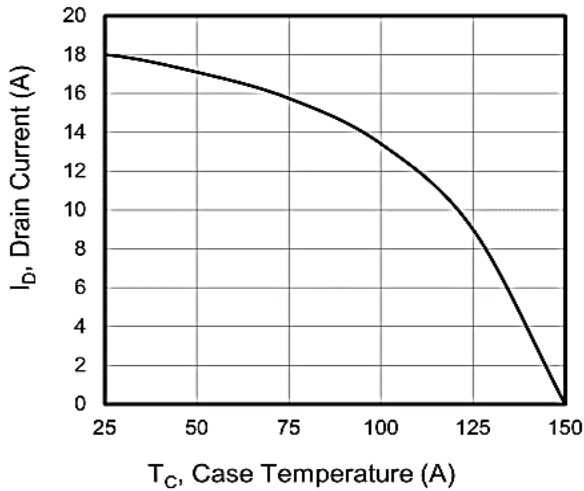

Figure 3. Drain Current vs. Temperature

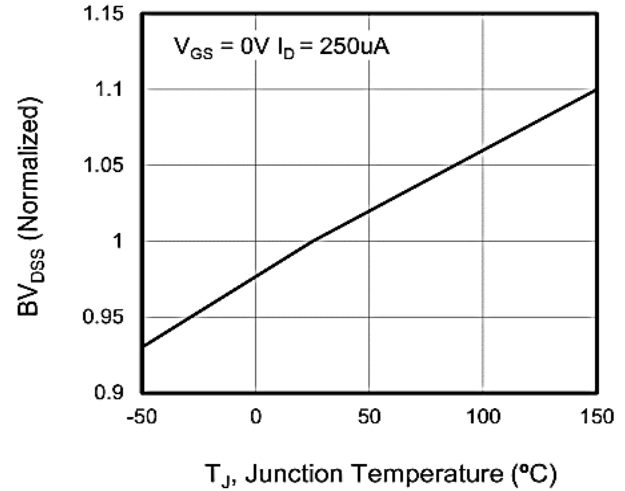

Figure 4. BV_{DSS} Variation vs. Temperature

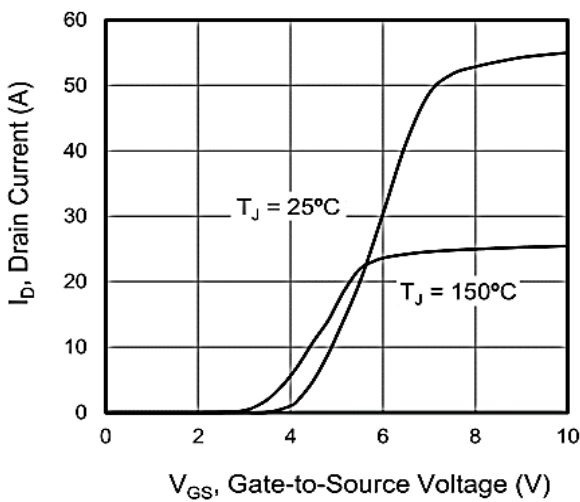

Figure 5. Transfer Characteristics

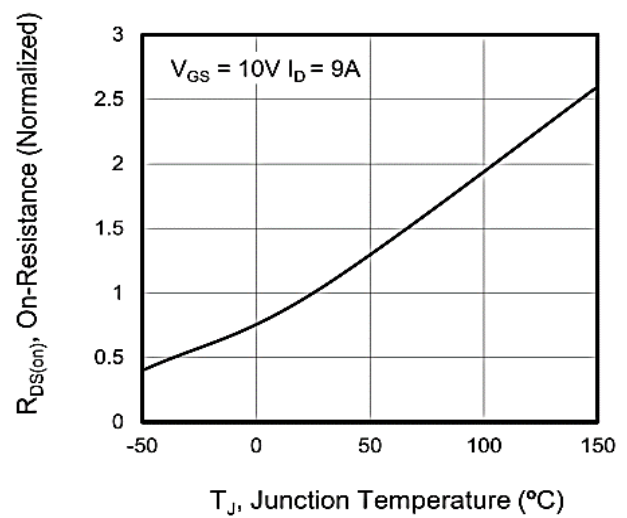

Figure 6. On-Resistance vs. Temperature

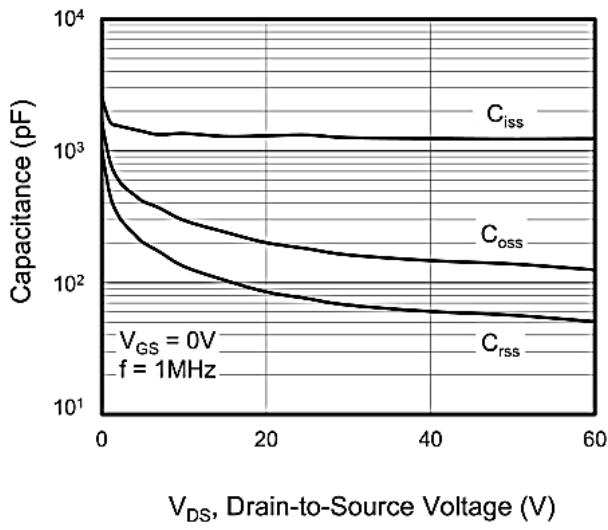

Figure 7. Capacitance

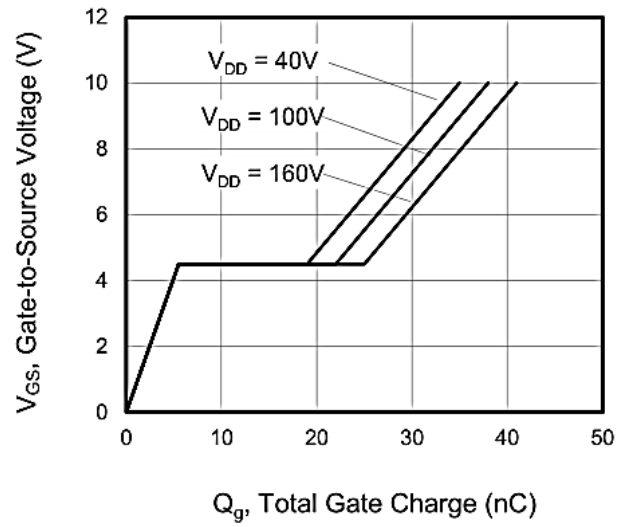

Figure 8. Gate Charge

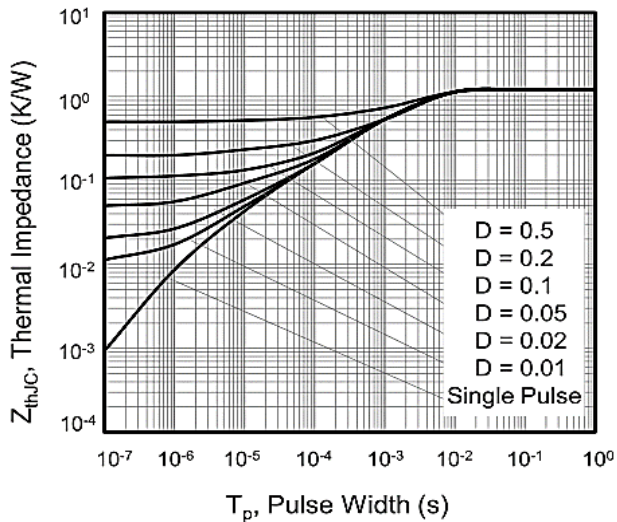
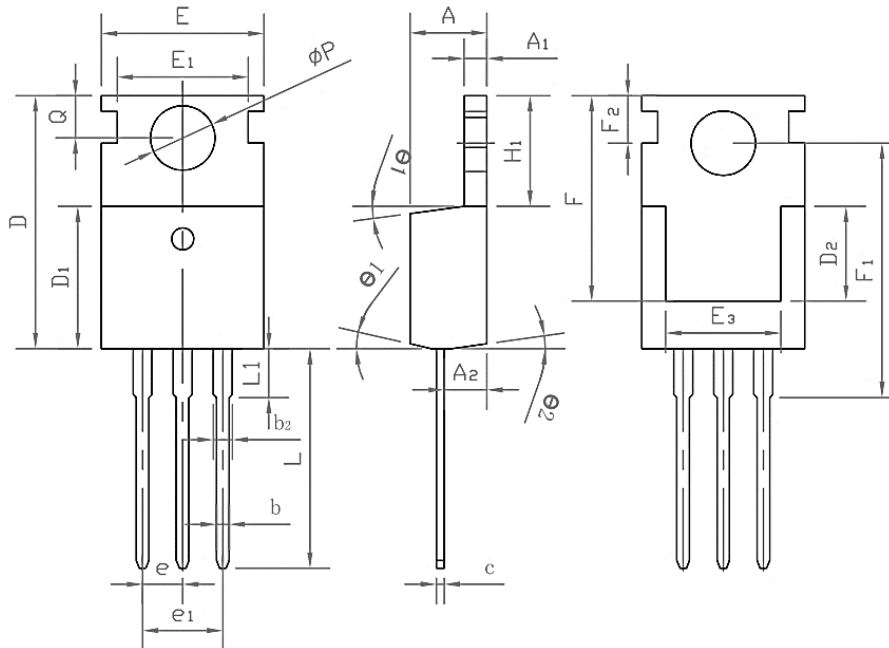

Figure 10. Transient Thermal Impedance

Package Mechanical Data-TO-220-3L

Symbol	Common		
	mm		
	Mim	Nom	Max
A	4.27	4.57	4.87
A1	1.15	1.30	1.45
A2	2.10	2.40	2.70
b	0.70	0.80	1.00
b2	1.17	1.27	1.50
D	0.40	0.50	0.65
D1	8.80	9.10	9.40
D2	5.70	6.70	7.00
E	9.70	10.00	10.30
E1	-	8.70	-
E2	9.63	10.00	10.35
E3	7.00	8.00	8.40
e		0.37	
e1		0.10	
H1	6.00	6.50	6.85
L	12.75	13.50	13.90
L1	-	3.10	3.40
Phi p	3.45	3.60	3.75
Q	2.60	2.80	3.00
theta 1	4°	7°	10°
theta 2	0°	3°	6°
F	13.30	13.50	13.70
F1	15.50	15.90	16.30
F2	2.80	3.00	3.20